

# Toul

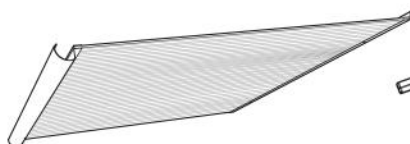

1 x1



2 x3



3 x3



4 x3



5 x6



6 x6



7 x6



8 x6

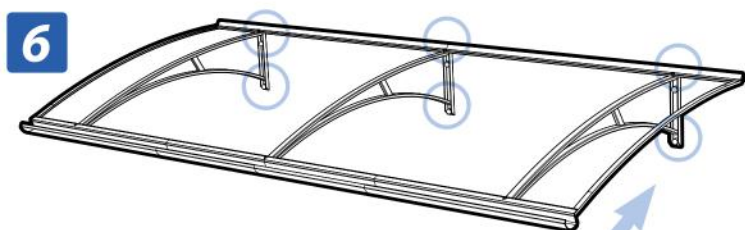
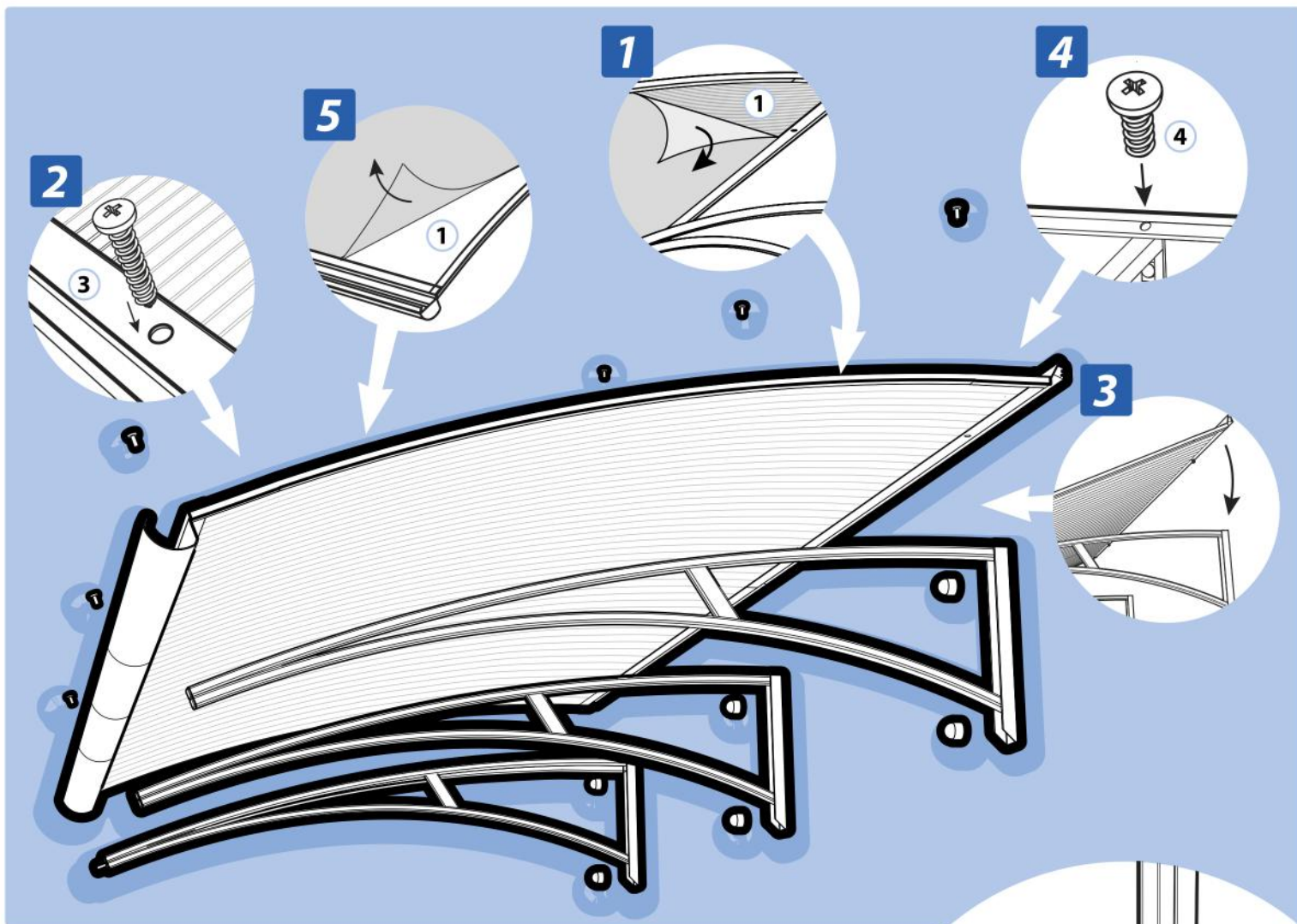

6

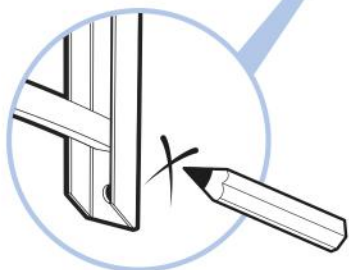

Ø 12 mm

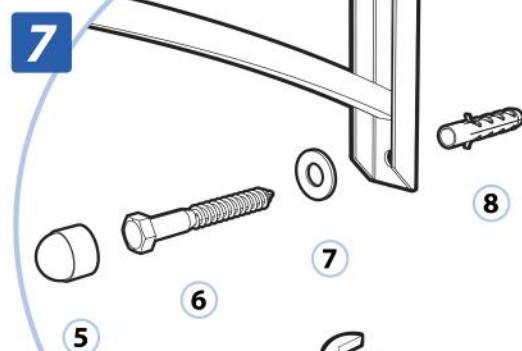
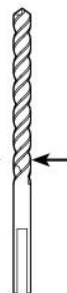

7

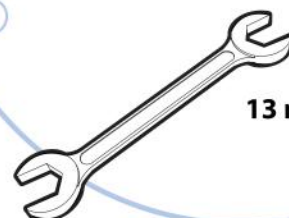

13 mm